

OUTLINE DIMENSIONS

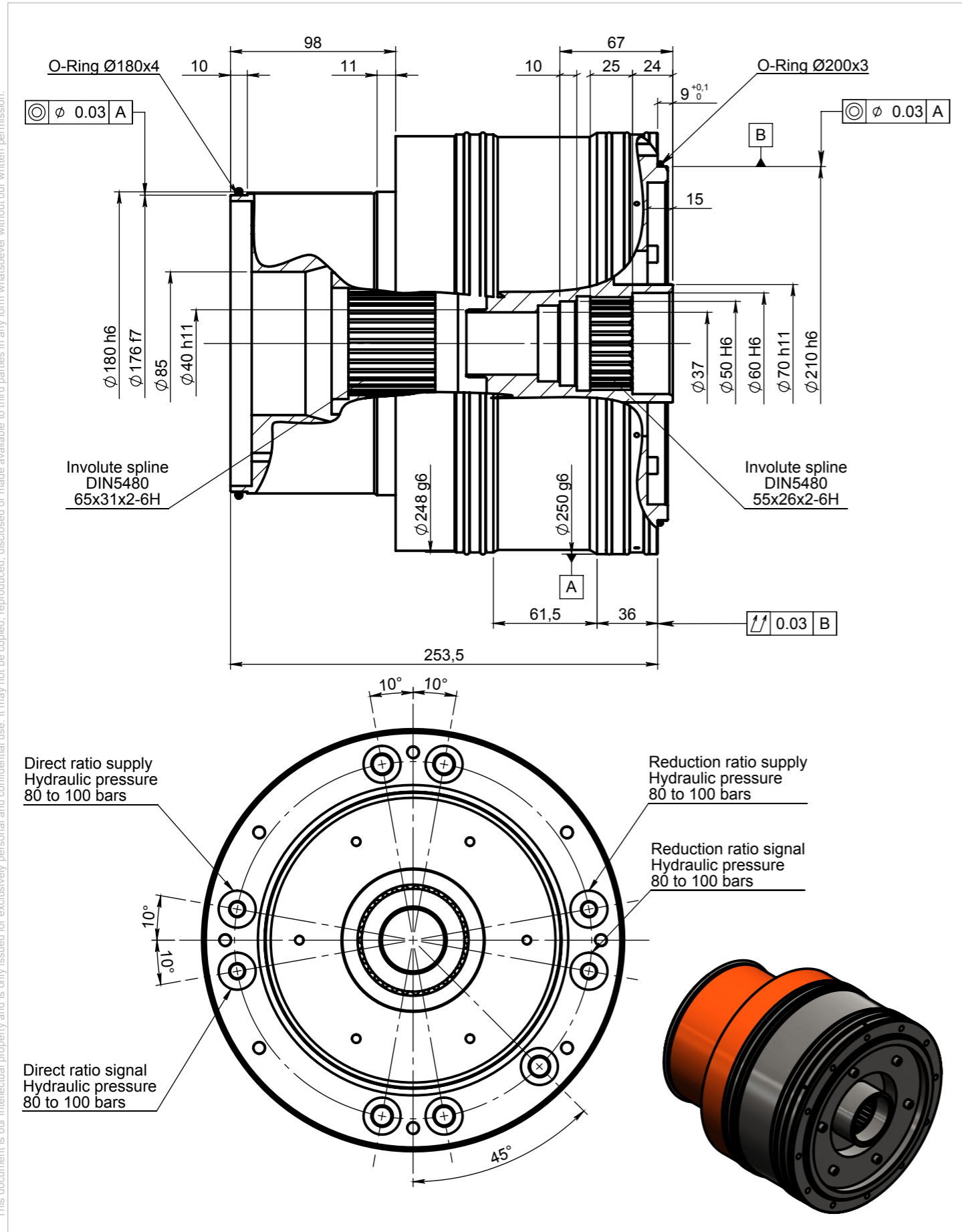

TECHNICAL FEATURES

PERFORMANCES

Unit codification		RAM250HiT
i1 High speed ratio		1,00
i2 Low speed ratio		5,00
T2B6 Maximum output torque (S6-40%)	Nm	2750
T2N1 Nominal output torque (S1-100%)	Nm	2000
n1B Maximum input speed	RPM	8000
n1N Nominal input speed	RPM	1500
OD External diameter	mm	250
ID Internal diameter	mm	38
li Input interfaces	mm	55x26x2-6H
lo Output interfaces	mm	65x31x2-6H
jt Backlash	arcmin	15
J1h Inertia @ input (high speed ratio)	Kg.mm²	5600
J1l Inertia @ input (low speed ratio)	Kg.mm²	4300
η Efficiency at rated input speed	%	97
Of Oil flow rate (input)	L/min	2,5 (2,5 - 6 bars)

ADDITIONAL FEATURES

- Paint RAL 2002
- All mounting positions possible, including swivelling mode (-150/+150°)
- Speed changer:
Pneumatic or hydraulic actuator – 2 positions
Pressure supply for gear change: 80 to 100 bar
Signal of gear changed: 80 to 100 bar
- Dry sump lubrication with synthetic PAO oil 10 to 32 cSt @ 40°C
- Cooling: oil or water

